

P 640

OUTSTANDING PERFORMANCE DATA

LIFETIME EXCELLENCE

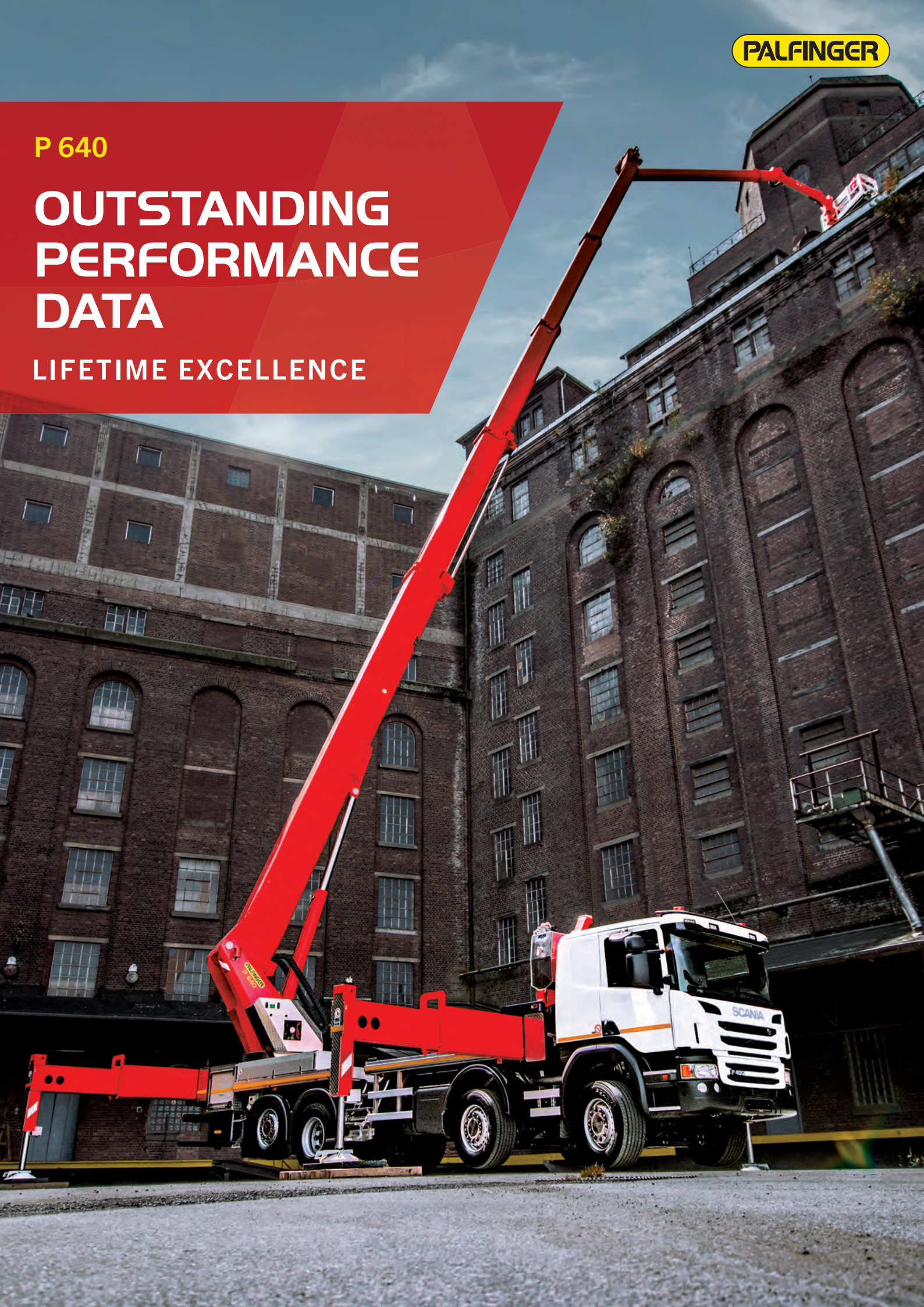

HIGHLIGHTS

- Greater working range thanks to 240° X-jib
- 2 x 200° rotation for perfect positioning of the workman basket
- Telescopic upper boom up to 19 m
- Can be mounted on four-axle chassis with 32 t
- Telescopic basket with 600 kg basket load and integrated preparation for Powerlift system
- Hanging basket enables users to get close to objects

STANDARDS













- Reverse camera
- Home function
- Automated positioning system
- Telescopic cage
- Driver information system
- Safety plates
- 230 V CEE current supply with CEE socket in the workman cage
- Assistance system
- Lubrication system lower arms

OPTIONS

- Access from both sides (access ladder on right and left-hand side) with lighting
- Vertical parallel manoeuvrability of the workman basket
- Seat bucket in the workman basket
- Attachable cable winch under the workman basket with 460 kg lifting capacity
- Additional camera for the passenger side
- Work in the basket up to wind force 8 (20 m/s)



TECHNICAL SPECIFICATIONS

	Total weight *	29900 kg		max. outreach	40.5 m
	Overall length	11.93 m		Rotation angle of turntable	540°
	Width in transportposition	2.51 m		Rotation angle of cage	2 x 200°
	Height in transportposition	3.97 m		Rotation angle of cage boom	240°
	max. stabiliser width	8.89 m		Size of cage	3.81 x 1.04 x 1.10 m
	max. working height	64 m		max. cage load	600 kg
	max. cage bottom height	62 m			

* Depends on truck chassis

WORKING DIAGRAMS

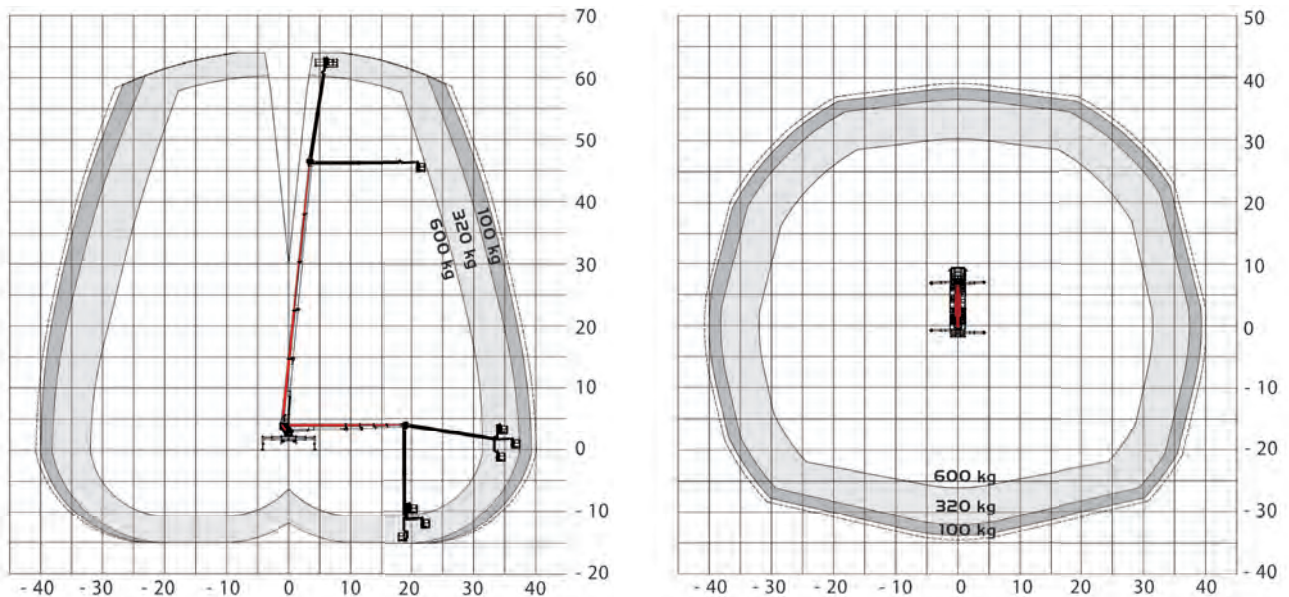

A possible 2% tolerance is contingent on structural components

DIMENSIONS

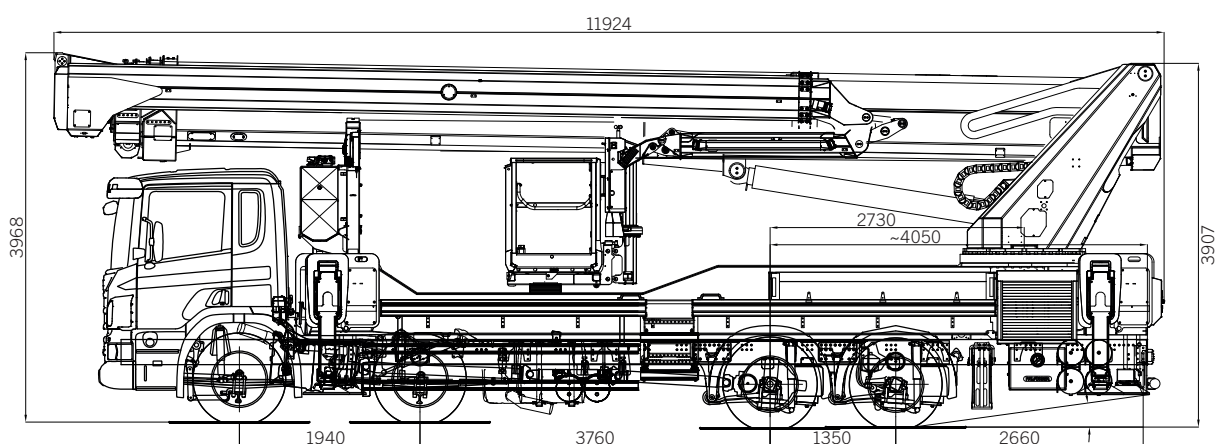

YOUR CONTACT

Palfinger Platforms GmbH

Düsseldorfer Str. 100
47809 Krefeld | Germany

KP-P640M2+EN

Units shown in the leaflet are partially optional equipped and do not always correspond to the standard version. Country-specific regulations must be observed. Dimensions may vary. Subject to technical changes, errors and translation mistakes.